

SEIKO

DIGITAL QUARTZ

Cal. A029A

PARTS LIST

Cal. A029A

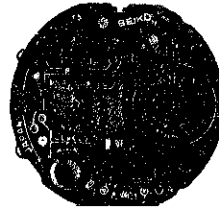
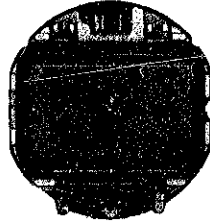

637 006

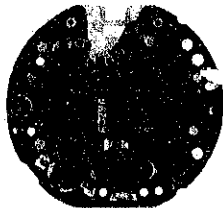

4001 107



4242 060



4245 021

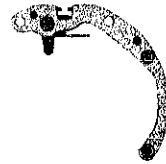

4303 003



4313 019



4398 039



4398 040



4458 002

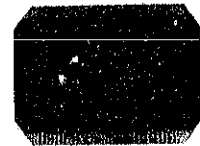

☆ 4510 231



4521 016



4530 006

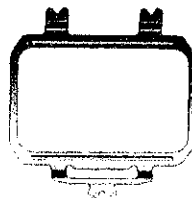

4540 003



4580 002



4586 001



☆ SEIKO SB-BU

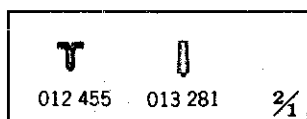

Cal. A029A

Characteristics

Casing diameter : ϕ 28.40 mm
 Maximum height : 6.45 mm without battery
 Frequency of quartz crystal oscillator : 32,768 Hz (Hz=Hertz Cycles per second)
 Time functions : 24-hour Digital Display System showing hour, minute & second.
 The dots blink once every second when date is indicated.
 Alarm functions : Timer, Alarm, Automatic alarm & Time signal
 Calendar functions : Date mark and date digits are displayed by simply depressing the front button.
 Display medium : Single Crystal Display (Nematic Liquid Crystal, FE-Mode)
 Time micro-adjustor : Trimmer condenser system
 Illumination light for digital display panel : Illuminated in accordance with the button depressing.
 Battery life indicator The entire display begins flashing.

PART NO.	PART NAME	PART NO.	PART NAME
637 006	Contact point spring lever		
4001 107	Circuit block		
4242 060	Plus terminal of battery connection		
4245 021	Setting switch spring		
4303 003	Switch block		
4315 019	Connector		
4398 039	Battery guard		
4398 040	Speaker frame		
4458 002	Battery guard holding lever		
☆4510 231	Liquid crystal panel		
4521 016	Reflecting mirror		
4530 006	Bulb		
4540 003	Spring for liquid crystal panel		
4580 002	Speaker block		
4586 001	Sound diaphragm		
012 455	Switch block screw		
013 281	Bulb pin		
☆SEIKO SB-BU ☆Maxell SR1130W	} Silver oxide battery		

Remarks :

☆Battery

The applied battery for this calibre might be added the substitutive in the future. In that case, please refer to separate "BATTERIES FOR SEIKO QUARTZ WATCHES".

☆Liquid crystal panel

The type of a liquid crystal panel is determined based on the design of watches. Check the case number and refer to "SEIKO Quartz Casing Parts List" to choose a corresponding liquid crystal panel.

☆⇔ Please see remarks.

Part numbers in light letters are not shown in photos.

TECHINICAL GUIDE

SEIKO DIGITAL QUARTZ

CAL. A029A

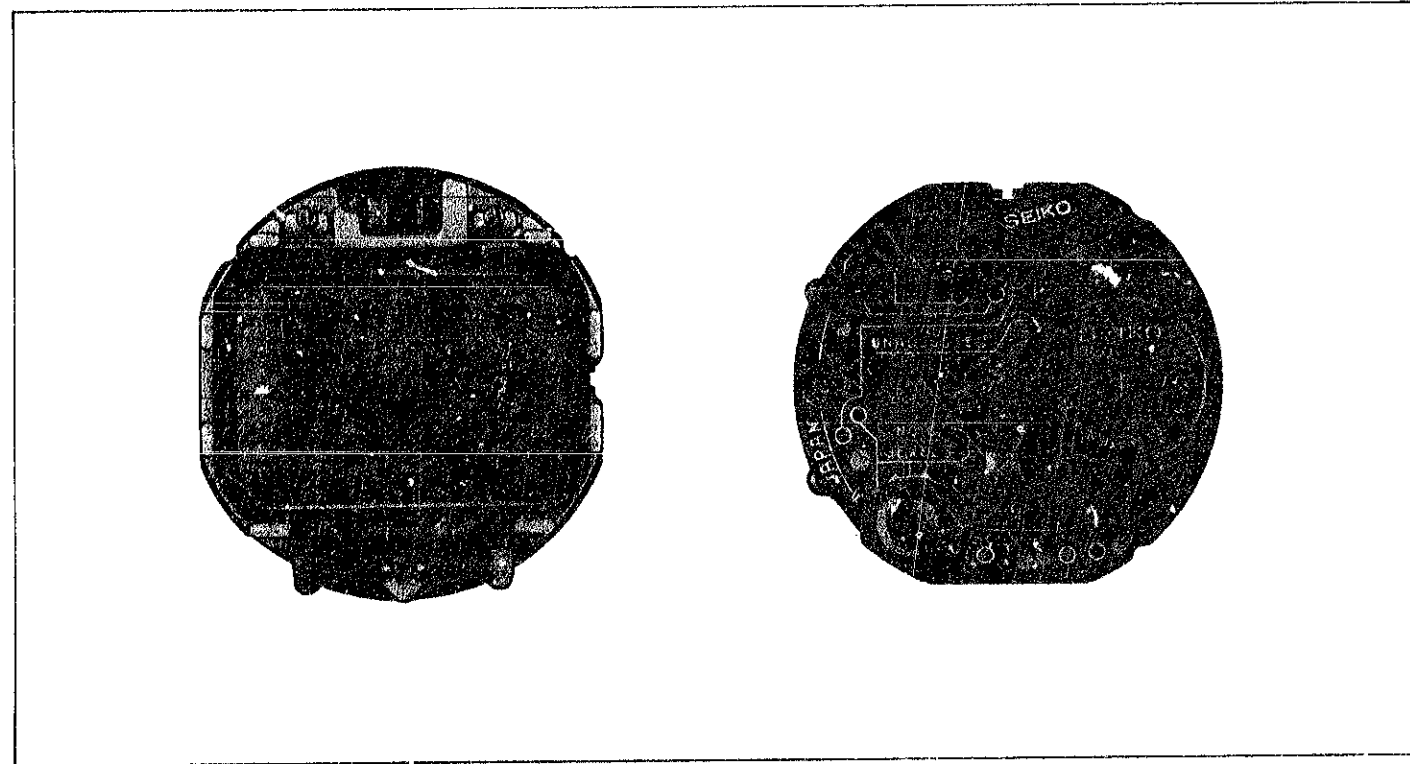

CONTENTS

I. SPECIFICATIONS	1
II. DISASSEMBLING, REASSEMBLING AND LUBRICATING OF THE CASE	2
III. DISASSEMBLING, REASSEMBLING AND LUBRICATING OF THE MODULE	4
1. Liquid crystal panel side	4
2. Switch mechanism side	6
IV. CHECKING AND ADJUSTMENT	8
1. Guide table for checking and adjustment	8
2. Procedures for checking and adjustment	9
A: Check battery voltage	9
B: Check battery conductivity	9
C: Check conductivity of liquid crystal panel, circuit block and connector	10
D: Check switch components	11
E: Check circuit block and liquid crystal panel	12
F: Check current consumption	13
G: Check accuracy	13
H: Check alarm sounding condition	13
I: Check bulb condition	14
J: Check functioning	14
K: Check battery life indicator	14

SEIKO

TECHNICAL GUIDE CAL. A029A

I. SPECIFICATIONS

Item	Calibre No. A029A
Display medium	Nematic Liquid Crystal, FEM (Field Effect Mode)
Display system	Time and calendar display Hour, minute and second : 24-hour Digital Display System Date : Automatic calendar system (The automatic calendar system automatically adjusts even and odd months except February.) * The date digits and the second digits can be selected as desired by depressing a button. TIMER: Hour, minute & second : 24-hour Digital Display System ALARM: Hour & minute : 24-hour Digital Display System AUTOMATIC ALARM: Hour & minute : 24-hour Digital Display System
Additional mechanism	Battery life indicator Alarm (Crystal sound system) ● Starts sounding at the required alarm time (Once for 10 seconds at a time.) ● Starts sounding every hour on the hour (When both the minute digits and the second digits indicate "00". If the date digits are displayed, the alarm does not operate.) Illuminating light Alarm volume control device
Crystal oscillator	32,768 Hz (Hz =Hertz Cycles per second)
Loss/gain	Loss/gain at normal temperature range Mean monthly rate: less than 10 seconds (Annual rate: less than 2 minutes)
Casing diameter	φ28.4mm (27.0mm between 3 o'clock and 9 o'clock sides)
Height	6.4mm without battery
Operational temperature range	-10°C ~ +60°C (14°F ~ 140°F)
Regulation system	Trimmer condenser
Battery power	Silver oxide battery SEIKO SB-BU Maxell SR1130W Battery life is approximately two years. (If the light is used 5 times a day and the alarm is used three times a day.) Voltage: 1.5V
IC (Integrated Circuit)	C-MOS-LSI 1 unit Bipolar - IC 1 unit

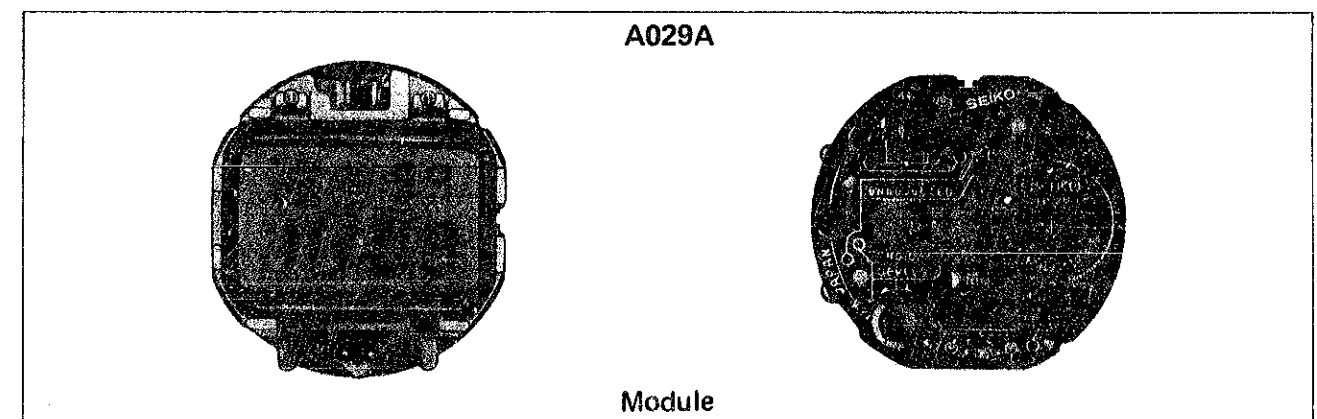

II. DISASSEMBLING, REASSEMBLING AND LUBRICATING OF THE CASE

Disassembling procedures Figs. : ①~⑩
 Reassembling procedures Figs. : ⑩~①

Lubricating  :
 Silicon grease 500,000 C.S., normal quantity

• Disassembling and reassembling of time adjusting button

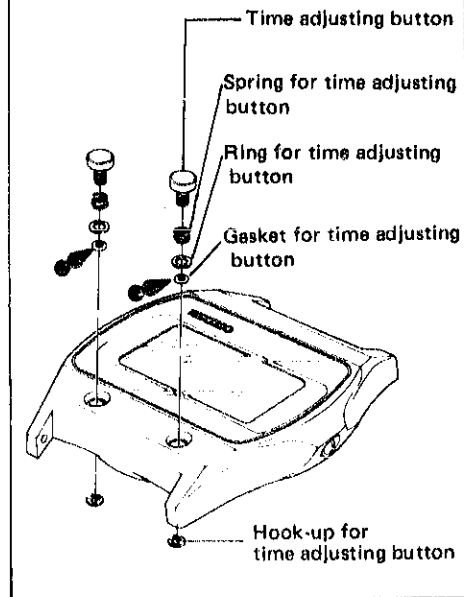

• Disassembling and reassembling of glass

It is not necessary to disassemble the glass except when replacement of parts or repair is necessary.

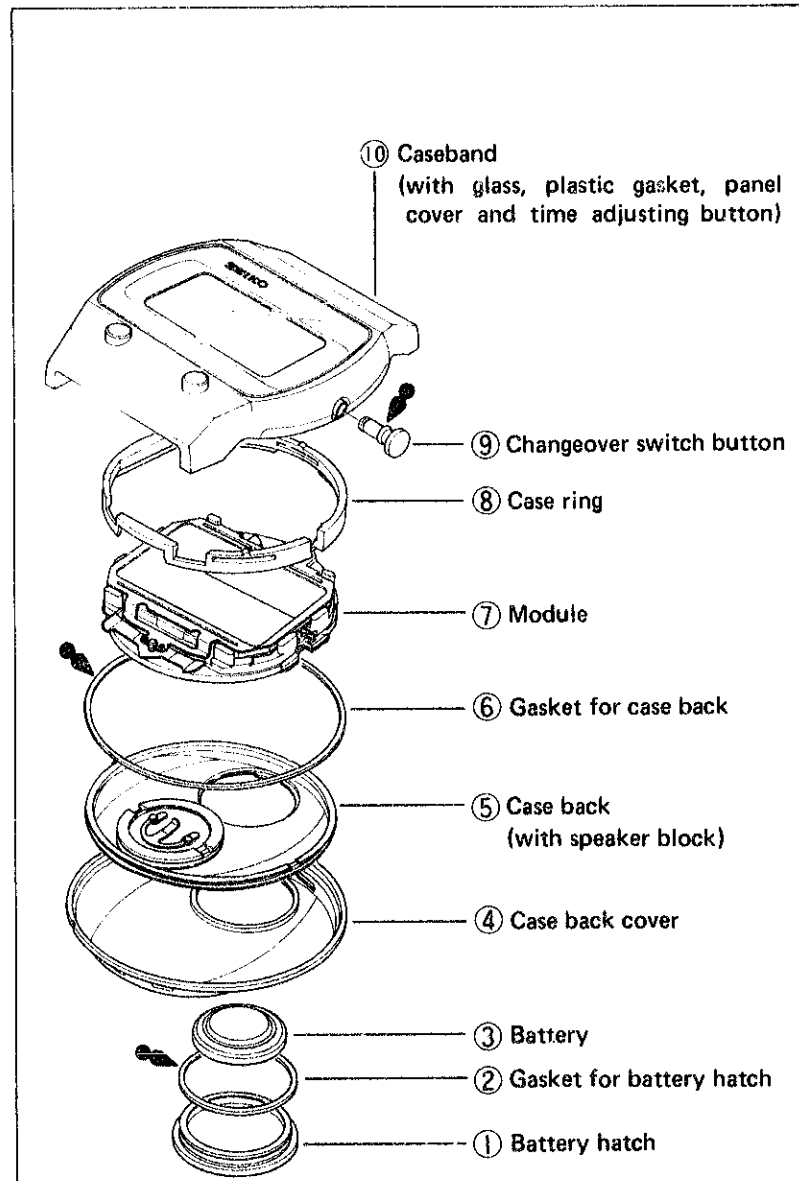
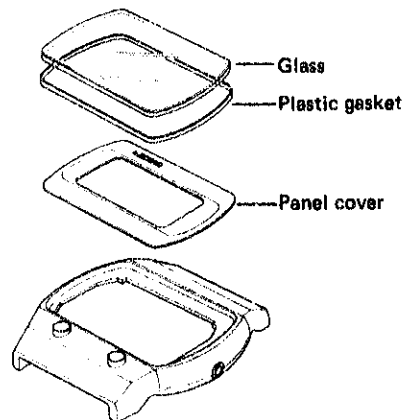

Remarks for disassembling and reassembling

④ Case back cover

Note for reassembling

Reassemble in the following order.

- (1) Reassemble the battery hatch in the case back.
- (2) Reassemble the case back cover on the case back.

(The case back cover can be positioned correctly by the battery hatch.)

- (3) Disassemble the battery hatch, reassemble the battery and then tighten the battery hatch for reassembling.

⑤ Case back

• How to disassemble the speaker block

It is not necessary to disassemble the speaker block except when replacement of parts or repair is necessary.

Use speaker frame opener (S-832) for the disassembling of the speaker frame.

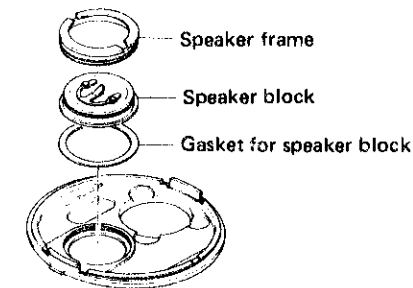
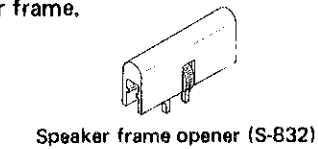

• How to disassemble the sound diaphragm of the speaker block

* Do not disassemble the sound diaphragm of the speaker block except when replacement of the sound diaphragm is necessary.

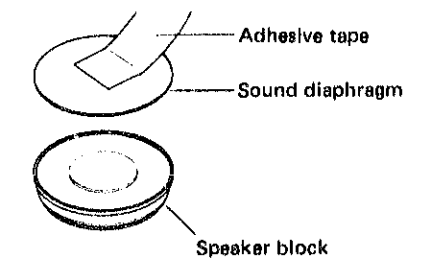

⑥ Gasket for case back

Note for reassembling

Reassemble the case back in the caseband after setting the gasket for case back on the case back.

Be careful not to mistake the upper side of the gasket for case back for the lower side.

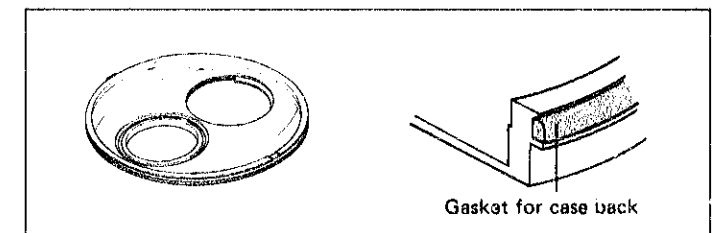

⑧ Case ring

Note for reassembling

Reassemble the case ring in the caseband after setting the case ring in the module.

⑩ Caseband

How to replace the glass

• How to disassemble the glass

Push the glass for disassembling by using the inserting disk S-161.

• How to reassemble the glass

Be sure to replace the plastic gasket with a new one. Push the glass for reassembling by using the inserting disk S-173.

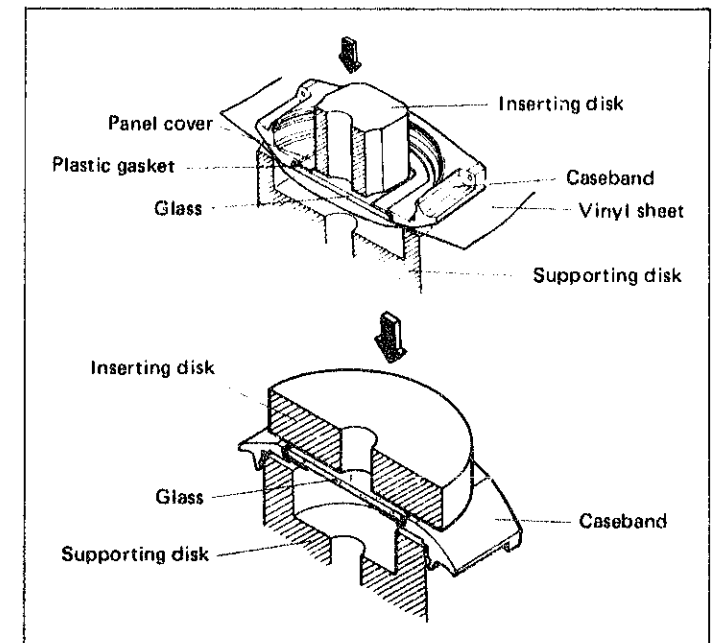

III. DISASSEMBLING, REASSEMBLING AND LUBRICATING OF THE MODULE

Disassembling procedures Figs.: ①~⑭

Reassembling procedures Figs.: ⑭~①

Lubricating  : SEIKO Watch Oil S-6, normal quantity

1. Liquid crystal panel side

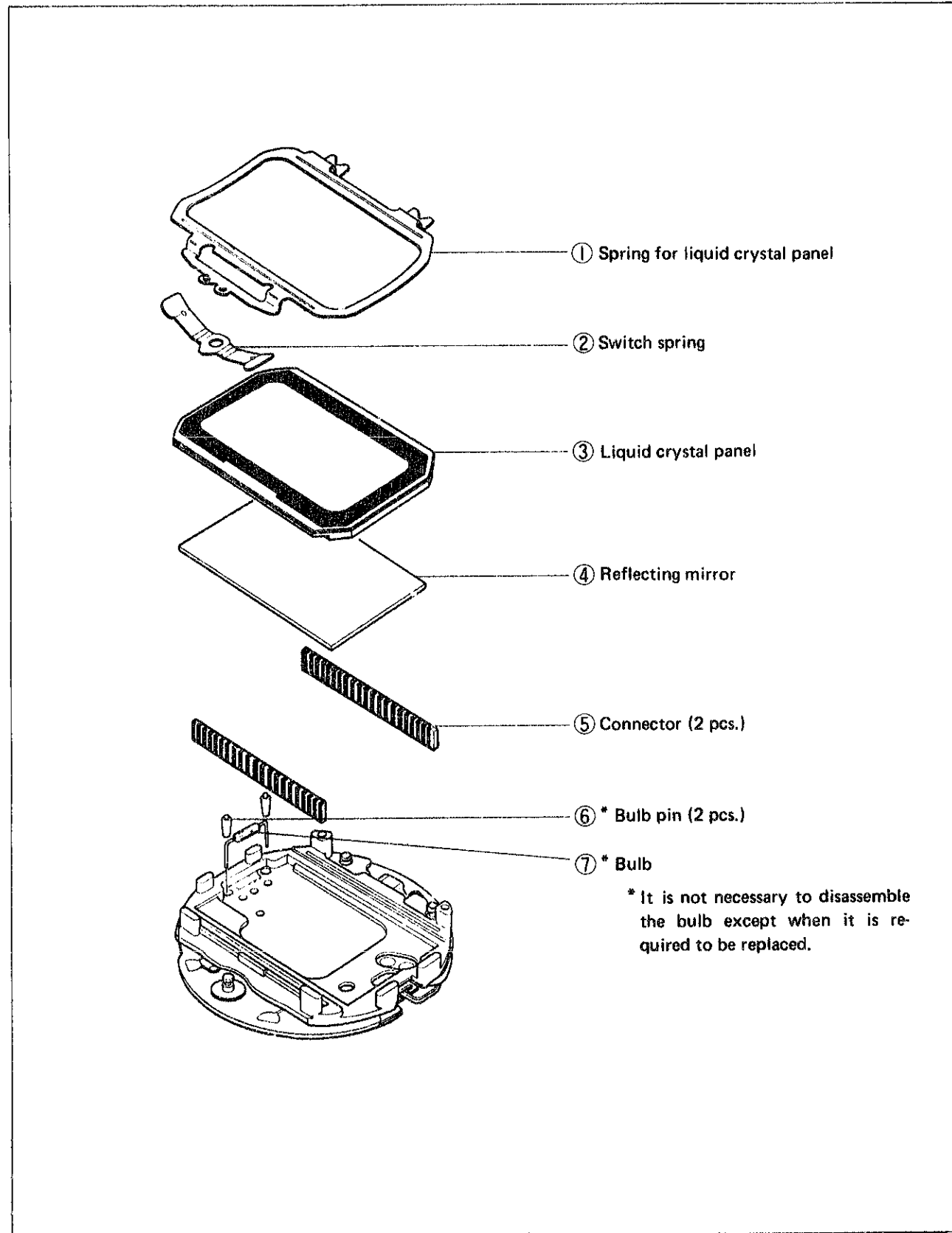

Remarks for disassembling and reassembling

① Spring for liquid crystal panel

Note for disassembling

Insert the tips of the tweezers into the two holes of the spring for liquid crystal panel and pry it up in the arrow-marked direction for disassembling.

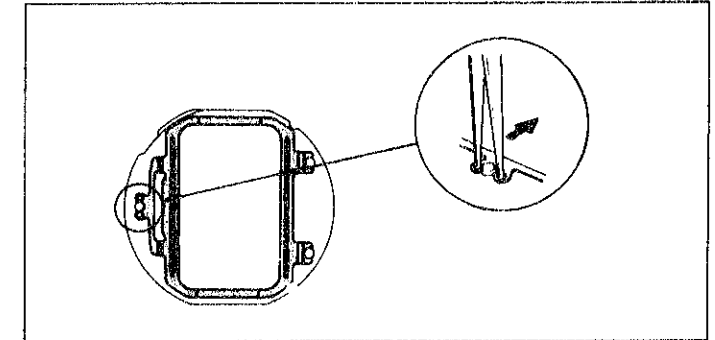

② Switch spring

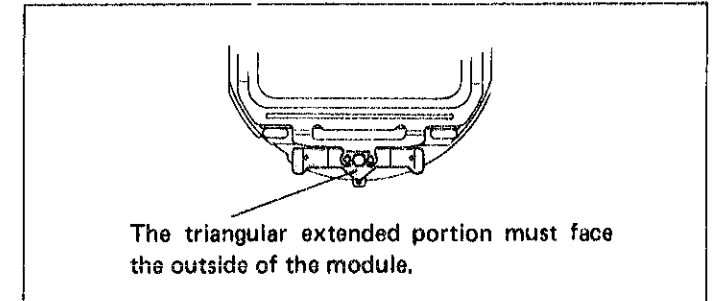

③ Liquid crystal panel

Use fingercots to disassemble and reassemble the liquid crystal panel.

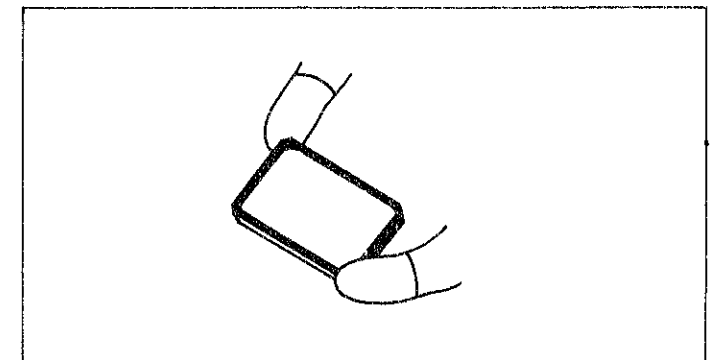

⑤ Connector

Although two connectors are used, there is no difference between the two. The black portions are conductive. Check to see if there are any scratches or contamination.

⑦ Bulb

When replacing the bulb, set it so that it touches the circuit block.

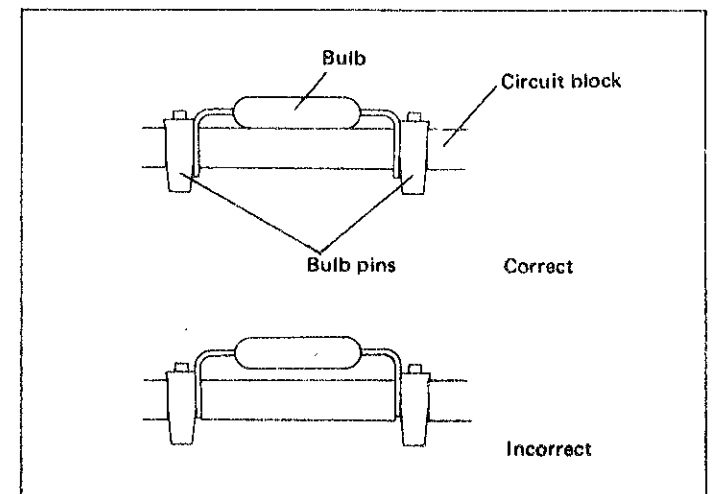

2. Switch mechanism side

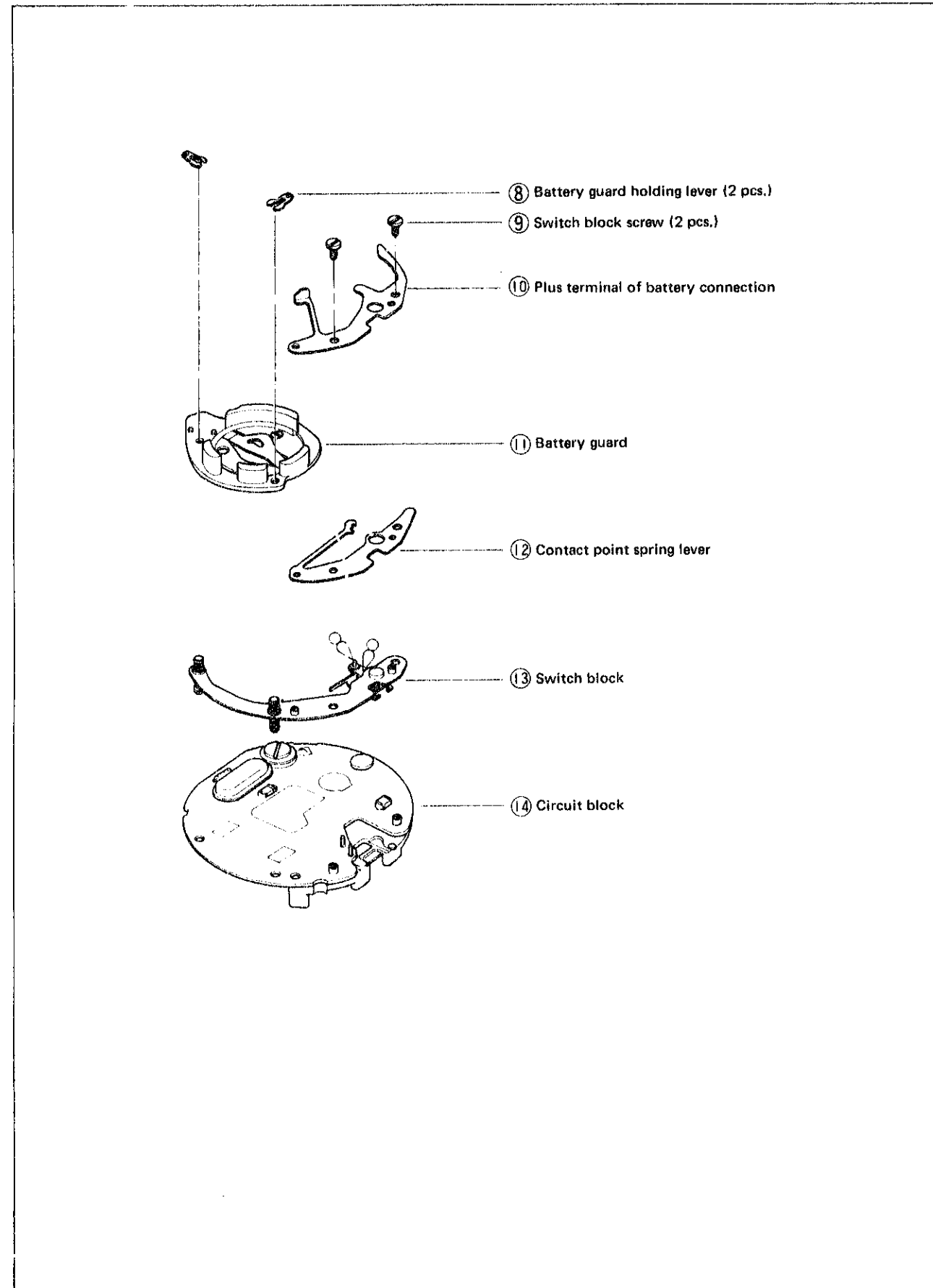

Remarks for disassembling and reassembling

8 Battery guard holding lever

Move the battery guard holding lever in the arrow-marked directions for disassembling and reassembling.

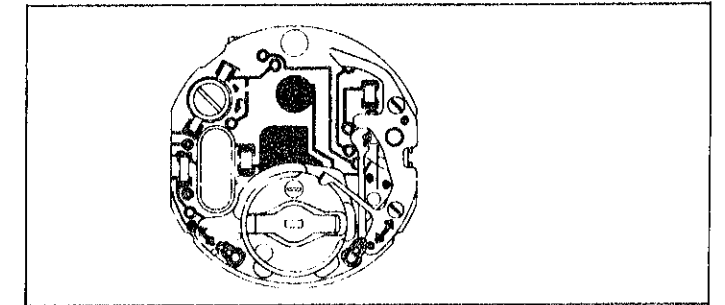

13 Switch block

Reassemble the contact point spring of the switch block in between the two pins (the unlock switch pin and the display switch pin) of the circuit block.

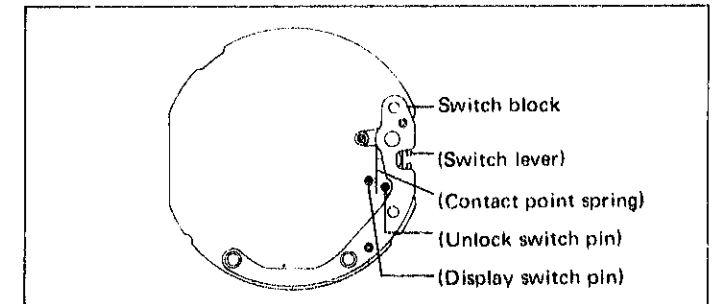

● Function of the switch block (contact point spring)

The contact point spring touches neither the unlock switch pin nor the display switch pin.

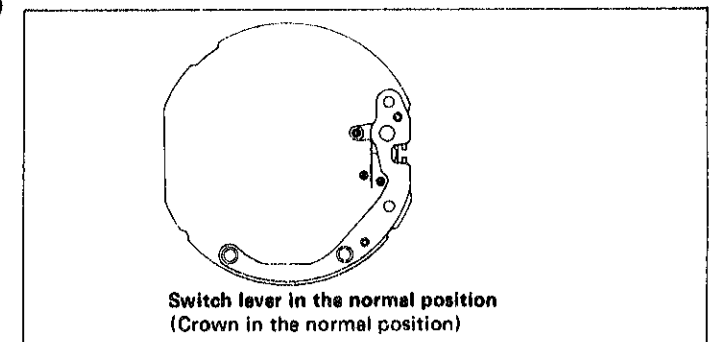

The contact point spring touches the unlock switch pin and this makes it possible for the display to be adjusted. (When the time digits are being displayed, the second digits are ready to be adjusted.)

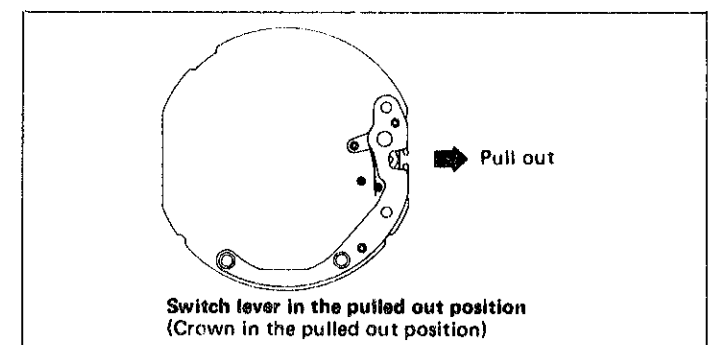

The contact point spring touches the display switch pin and this enables the changeover to and from the time display and the alarm display.

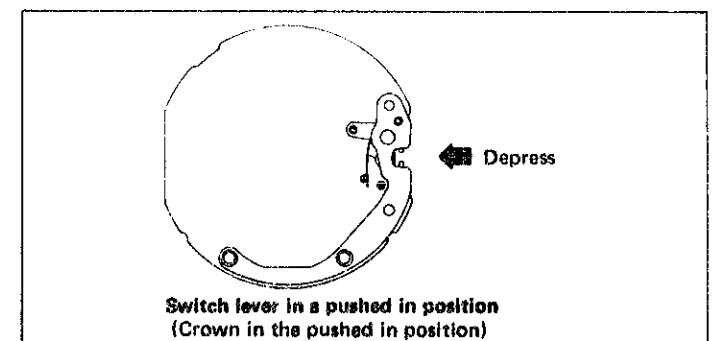

IV. CHECKING AND ADJUSTMENT

1. Guide table for checking and adjustment

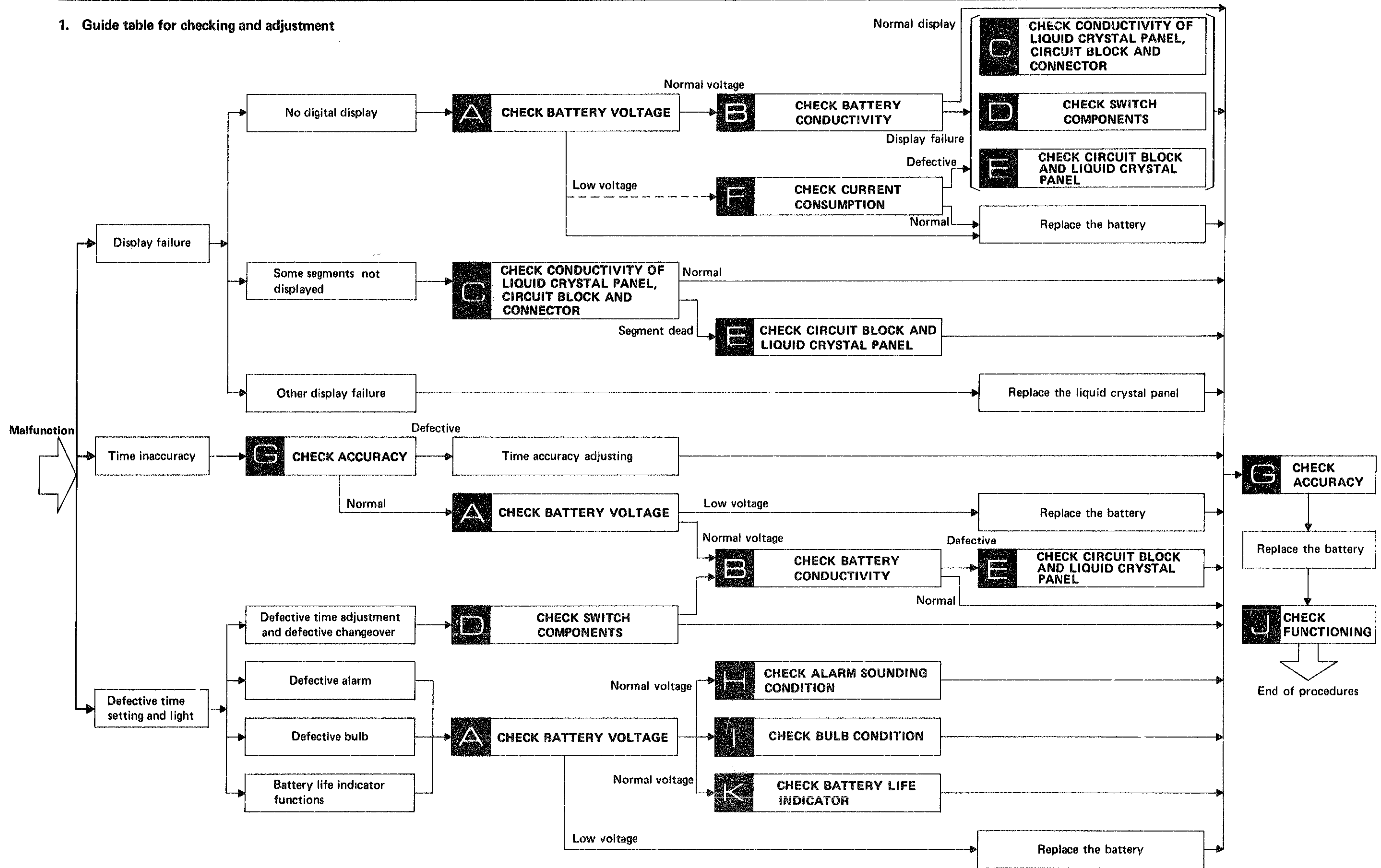

Note:

If it is difficult to locate the malfunctioning portion, proceed to

J CHECK FUNCTIONING first.

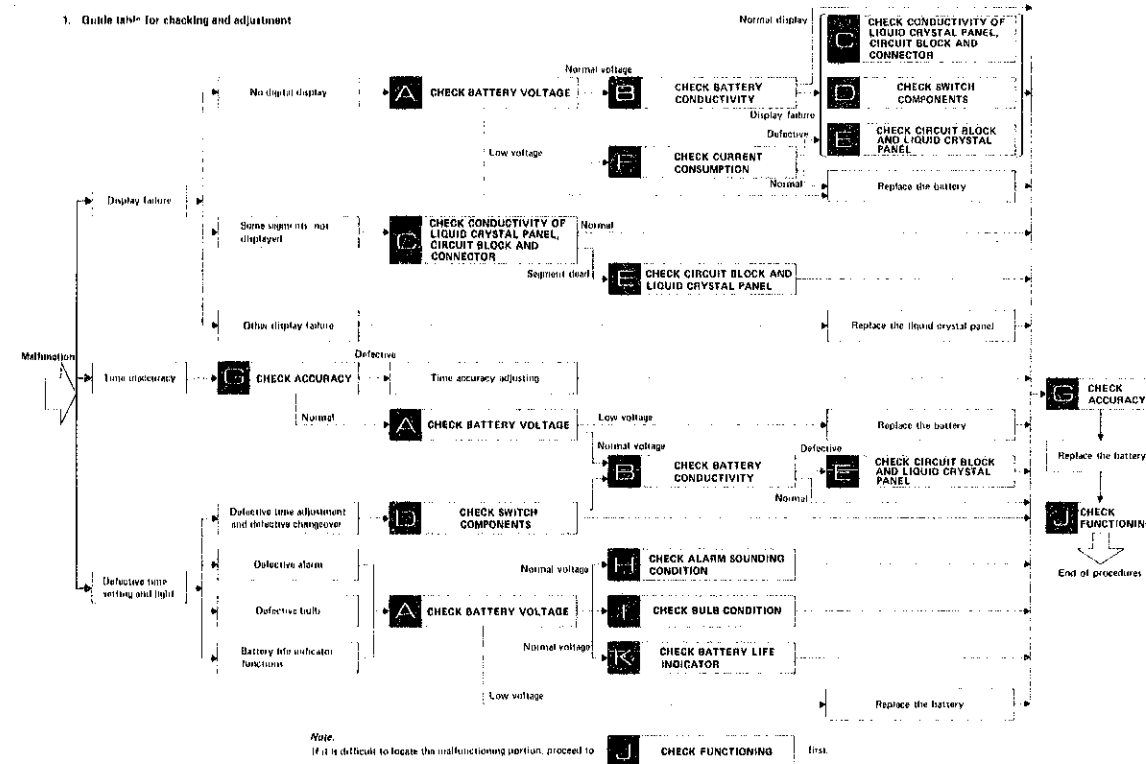

2 Procedures for checking and adjustment

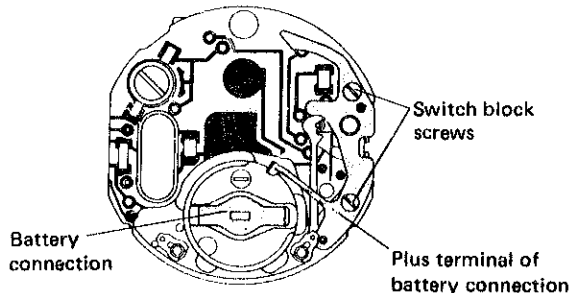

	Procedure	Result	Adjustment and Repair
A CHECK BATTERY VOLTAGE	Check battery voltage.	More than 1.5 V → Normal Less than 1.5 V → Defective	Replace the battery.
B CHECK BATTERY CONDUCTIVITY	<ol style="list-style-type: none"> 1. Make sure that the screws are tightened firmly. 2. Check for any contamination on the connecting portions with the battery.  <ol style="list-style-type: none"> 3. Check to see if there is battery electrolyte leakage. <ul style="list-style-type: none"> ○ How to repair battery electrolyte leakage <ol style="list-style-type: none"> 1) Remove the module from the case. 2) Disassemble the module. 3) Clean the parts contaminated with battery electrolyte. <ul style="list-style-type: none"> • Clean the circuit block. <ol style="list-style-type: none"> ① Wipe off battery electrolyte on the circuit block with a cloth moistened with distilled water (or normal tap water) first and then with a cloth moistened with alcohol. • Note: <ul style="list-style-type: none"> ○ Do not use a cloth which gives off lint such as gauze, flannel, etc. ○ Be careful that the trimmer condenser is not exposed to water or alcohol. ② Dry with cool air by using a dryer. • Clean the other parts. <ol style="list-style-type: none"> ① Wipe off battery electrolyte on the other parts with a soft brush moistened with distilled water (or normal tap water) and then rinse them with alcohol. ② Dry with cool air by using a dryer. 4) Reassemble the module and replace the battery with a new one. 5) Check to see if the time setting functions and the current consumption are normal. 	No loosened screws → Normal Loosened screws → Defective Retighten screws. Uncontaminated → Normal Contaminated → Defective Wipe off any foreign matter. Battery electrolyte leakage → Wipe off battery electrolyte by following the repairing procedure. No battery electrolyte leakage → Normal Battery electrolyte leakage → Defective Replace the connector with a new one.	

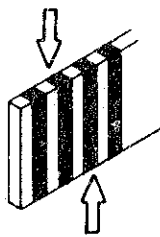
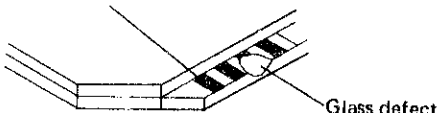
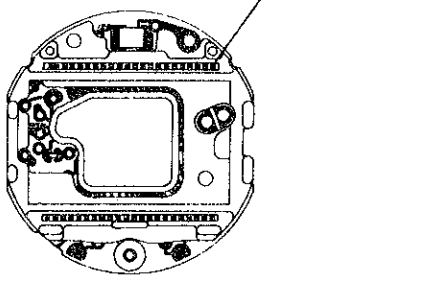
CHECK CONDUCTIVITY OF LIQUID CRYSTAL PANEL, CIRCUIT BLOCK AND CONNECTOR

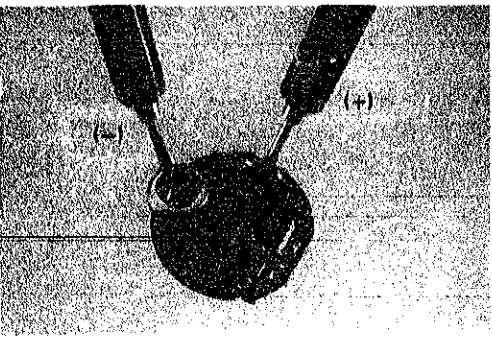
	Procedure	Result	Adjustment and Repair
	<p>1. Check for any contamination, crack or tiny break of the connector.</p>	<p>No contamination, crack or tiny break → Normal</p>	
		<p>Contaminated → Defective</p>	<p>Wipe off any foreign matter.</p>
		<p>Crack or tiny break → Defective</p>	<p>Replace the connector with a new one.</p>
<p>Liquid crystal panel electrode</p> 	<p>2. Check for any contamination and glass defect of the liquid crystal panel electrode.</p>	<p>No contamination or glass defect → Normal</p>	
		<p>Contaminated → Defective</p>	<p>Wipe off any foreign matter.</p>
		<p>Glass defect → Defective</p>	<p>Replace the liquid crystal panel with a new one.</p>
<p>Circuit block electrode</p> 	<p>3. Check for any contamination on the circuit block electrode.</p>	<p>Uncontaminated → Normal</p>	
		<p>Contaminated → Defective</p>	<p>Wipe off any foreign matter.</p>

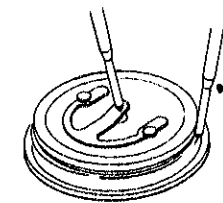
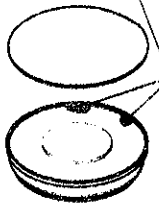
	Procedure	Result	Adjustment and Repair
CHECK CURRENT CONSUMPTION	Probe Red (+) ... Battery connection Probe Black (-) ... Battery surface (-) 	Less than $2.5 \mu A$ → Normal More than $2.5 \mu A$ → Defective Proceed to [] , [] and [].	
CHECK ACCURACY	Check gain and loss of time.	No gain or loss → Normal Gain or loss → Defective Proceed to Time accuracy adjusting.	
CHECK ALARM SOUNDING CONDITION	<ul style="list-style-type: none"> When the alarm does not sound. <ol style="list-style-type: none"> Check for any contamination or bent of the lead terminal of the speaker block.  Check for any broken coil wire or short-circuit of the speaker block. Set up the volt-ohm-meter. Range to be used: OHMS R x 1 Apply red and black probes of the volt-ohm-meter to the speaker frame and the lead terminal of the speaker block. (Either red or black probe will do.)  <ul style="list-style-type: none"> When the alarm sound is not clear <ol style="list-style-type: none"> Check for any contamination or bent of the sound diaphragm. Contamination  (See "Remarks for disassembling and reassembling" for the disassembling procedures of the sound diaphragm.) 	Uncontaminated and not bent → Normal Contaminated → Defective Wipe off any foreign matter. Bent → Defective Correct by using tweezers. $70\Omega \sim 90\Omega$ → Normal Less than 70Ω (short-circuit) → Defective More than 90Ω (broken coil wire) → Defective Replace the speaker block with a new one.	

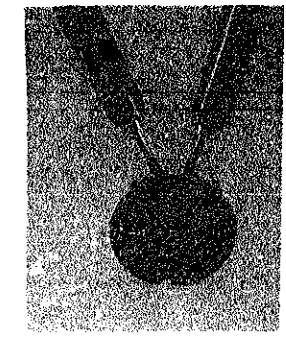
	Procedure	Result	Adjustment and Repair
CHECK BULB CONDITION	Set up the volt-ohm-meter. Range to be used: OHMS R x 1 Apply red and black probes of the volt-ohm-meter to the two terminals of the bulb. (Either red or black probe can be applied.) 	Lights up → Normal Does not light up → Defective Replace the bulb with a new one.	
CHECK FUNCTIONING	Check to see if the changeover and the adjustment of the display can be made correctly by button operation.		
CHECK BATTERY LIFE INDICATOR	<ol style="list-style-type: none"> Set up the Micro Test. Set the voltage at 1.1 V. Clip Red (+) ... Case back (or crown) Probe Black (-) ... Battery connection Set up the Micro Test. Set the voltage at 1.5 V. Clip Red (+) ... Case back (or crown) Probe Black (-) ... Battery connection 	Flashes → Normal Does not flash → Defective Replace the circuit block with a new one. Does not flash → Normal Flashes → Defective Replace the circuit block with a new one.	

All procedures of Disassembling, Reassembling, Checking and Adjustment are completed.